

DAIKIN



INSTALLATION MANUAL

Packaged air-cooled water chillers

EWAD120MBYNN
EWAD150MBYNN
EWAD170MBYNN
EWAD240MBYNN
EWAD300MBYNN
EWAD340MBYNN
EWAD380MBYNN
EWAD460MBYNN
EWAD520MBYNN
EWAD600MBYNN



1



2



3

CONTENTS

	Page
Introduction	1
Technical specifications	1
Electrical specifications	1
Options and features	1
Operation range	2
Operation range	2
Main components	2
Selection of location	2
Inspecting and handling the unit	2
Unpacking and placing the unit	2
Important information regarding the refrigerant used	3
Preparing, checking and connecting the water circuit	3
Water charge, flow and quality	4
Piping insulation	4
Field wiring	4
Parts table	4
Power circuit and cable requirements	4
Connection of the air-cooled water chiller power supply	5
Interconnection cables	5
Connection and setup of a DICN system	5
Cable for remote digital controller	5
Before starting	6
How to continue	8

Thank you for purchasing this Daikin air conditioner.



READ THIS MANUAL ATTENTIVELY BEFORE STARTING UP THE UNIT. DO NOT THROW IT AWAY. KEEP IT IN YOUR FILES FOR FUTURE REFERENCE.

IMPROPER INSTALLATION OR ATTACHMENT OF EQUIPMENT OR ACCESSORIES COULD RESULT IN ELECTRIC SHOCK, SHORT-CIRCUIT, LEAKS, FIRE OR OTHER DAMAGE TO THE EQUIPMENT. BE SURE ONLY TO USE ACCESSORIES MADE BY DAIKIN WHICH ARE SPECIFICALLY DESIGNED FOR USE WITH THE EQUIPMENT AND HAVE THEM INSTALLED BY A PROFESSIONAL.

IF UNSURE OF INSTALLATION PROCEDURES OR USE, ALWAYS CONTACT YOUR DAIKIN DEALER FOR ADVICE AND INFORMATION.

INTRODUCTION

The Daikin EWAD-MBYNN air-cooled water chillers are designed for outdoor installation and used for cooling applications only. The units are available in 10 standard sizes with nominal cooling capacities ranging from 120 to 605 kW.

The EWAD units can be combined with Daikin fan coil units or air handling units for air conditioning purposes. They can also be used for supplying chilled water for process cooling.

The present installation manual describes the procedures for unpacking, installing and connecting the EWAD units.

Technical specifications⁽¹⁾

Model EWAD	120	150	170
Refrigerant	R134a		
Dimensions HxWxD (mm)	2221x3973x1109		
Weight			
• machine weight (kg)	1391	1600	1705
• operation weight (kg)	1441	1663	1768
Connections			
• Water inlet	Ø3" (88.9 mm OD)	Ø4" (114.3 mm OD)	Ø4" (114.3 mm OD)
• Water outlet	Ø3" (88.9 mm OD)	Ø4" (114.3 mm OD)	Ø4" (114.3 mm OD)

Model EWAD	240	300	340
Refrigerant	R134a		
Dimensions HxWxD (mm)	2250x4280x2238		
Weight			
• Machine weight (kg)	2710	3210	3260
• Operation weight (kg)	2790	3340	3390
Connections			
• Water inlet	Ø4" (114.3 mm OD)	Ø5" (141.3 mm OD)	Ø5" (141.3 mm OD)
• Water outlet	Ø4" (114.3 mm OD)	Ø5" (141.3 mm OD)	Ø5" (141.3 mm OD)

Model EWAD	380	460	520	600
Refrigerant	R134a			
Dimensions HxWxD (mm)	2250x5901x2238			
Weight				
• machine weight (kg)	5335	5595	5775	5855
• operation weight (kg)	5497	5779	5959	6039
Connections				
• Water inlet	Ø6" (168.3 mm OD)			
• Water outlet	Ø6" (168.3 mm OD)			

Electrical specifications⁽¹⁾

Model EWAD	120-600
Power circuit	
• Phase (kg)	3~
• Frequency (Hz)	50
• Voltage (V)	400
• Voltage tolerance (%)	±10

Options and features⁽¹⁾

Options

- Suction stopvalve
- Ampere and voltmeter
- Main isolator switch
- Dual pressure relief valve
- Low noise operation
- Condenser protection grills
- BMS Connection (MODBUS/J-BUS, BACNET)
- Inverter fans
- High ESP fans

(1) Refer to the operation manual or engineering data book for the complete list of specifications, options and features.

Features

- Stepless capacity control (15 or 30~100%)
- Evaporator heatertape
- Low ambient operation (-15°C)
- Liquid line solenoid valve
- Sight glass with moisture indication
- Voltage free contacts
 - general operation/pump/contact
 - alarm
 - operation circuit 1
 - operation circuit 2 (only for EWAD240~600)
- Remote inputs
 - remote start/stop
 - dual setpoint
 - disable circuit 1 (only for EWAD240~600)
 - disable circuit 2 (only for EWAD240~600)
- Daikin Integrated Chiller Network (DICN)
- Glycol application for leaving evaporator water down to -10°C
- Electronic expansion valves for EWAD380~600

OPERATION RANGE

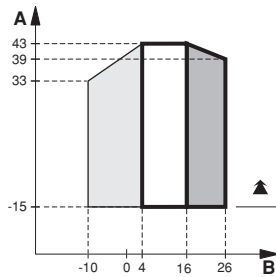

- A Outdoor temperature (°C DB)
- B Leaving water temperature evaporator (°C)
- Standard operation range
- Standard
- Range for pull down operation
- Range when adding glycol

MAIN COMPONENTS (refer to the outlook diagram supplied with the unit)

- 1 Evaporator
- 2 Condenser
- 3 Compressor 1
- 4 Discharge stopvalve
- 5 Liquid stopvalve
- 6 Suction stopvalve (optional)
- 7 Chilled water in
- 8 Chilled water out
- 9 Water drain evaporator
- 10 Air purge evaporator
- 11 Leaving water temperature sensor (R4T)
- 12 Entering water temperature sensor (R3T)
- 13 Ambient temperature sensor (R5T)
- 14 Drier + charge valve
- 15 Power supply intake
- 16 Emergency stop (S5E)
- 17 Switchbox
- 18 Digital display controller
- 19 Field wiring intake
- 20 Main isolator switch (optional - S13S)
- 21 Compressor 2

SELECTION OF LOCATION

This is a class A product. In a domestic environment this product may cause radio interference in which case the user may be required to take adequate measures.

The units are designed either for roof mounting or ground level mounting and should be installed in a location that meets the following requirements:

- 1 The foundation is strong enough to support the weight of the unit and the floor is flat to prevent vibration and noise generation.
- 2 The space around the unit is adequate for servicing and the minimum space for air inlet and air outlet (refer to the operation manual) is available.
- 3 There is no danger of fire due to leakage of inflammable gas.
- 4 Select the location of the unit in such a way that neither the discharged air nor the sound generated by the unit disturb anyone.
- 5 Make sure that the air inlet and outlet of the unit are not positioned towards the main wind direction. Frontal wind will disturb the operation of the unit. If necessary, use a windscreen to block the wind.
- 6 Ensure that water cannot cause any damage to the location in case it drips out of the unit.

INSPECTING AND HANDLING THE UNIT

At delivery, the unit should be checked and any damage should be reported immediately to the carrier claims agent.

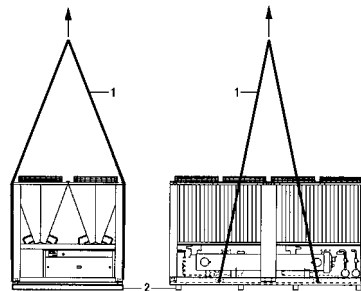

When handling the unit, take into account the following:

- 1 Lift the unit preferably with a crane and belts in accordance with the instructions on the unit. The length of the ropes (1) to be used for lifting are 6 m minimum each.
- 2 The unit is shipped with wooden beams (2) under it, these have to be removed before installation.

NOTE Try to reduce the drilling in the unit to a minimum. If drilling is impreventable, remove the iron filling thoroughly in order to prevent surface rust!

UNPACKING AND PLACING THE UNIT

- 1 Remove the wooden beams from the unit.
- 2 Install vibration mountings in case of a roofmounted unit or other installation where noise and vibration might be an impediment.
- 3 Set the unit on a solid and level foundation.

Roof mounted:	The unit should be installed on steelchannel or I-beam frame to support the unit on the roof, or it can be installed on a concrete base.
Ground level mounted:	The unit should be installed on a solid base. It is recommended to fix the unit on a concrete base with anchor bolts.

Ground level mounting

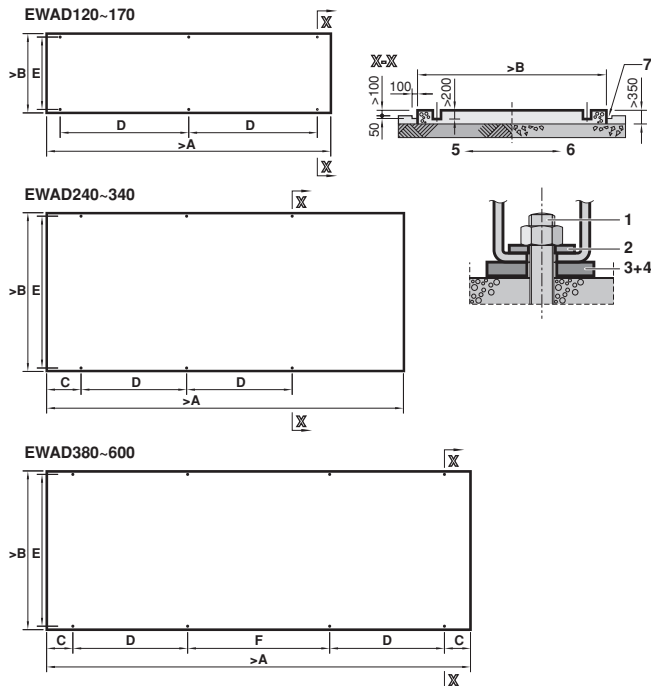

- Fix anchor bolts (1) into the concrete foundation. When finally fixing the unit by means of these anchor bolts, make sure that the washers for channel DIN434 (2), and both field supplied rubber plates (3) and field supplied raw cork or rubber sheets (4) for better vibration protection, are installed as indicated.
- The concrete foundation should approximately be 100 mm higher than the floor level for ease of plumbing work and better drain.

Model	A	B	C	D	E	F	anchor bolt size	Qty
EWAD120	3980	1110	—	1800	1013	—	M16x200	6
EWAD150	3980	1110	—	1800	1013	—	M16x200	6
EWAD170	3980	1110	—	1800	1013	—	M16x200	6
EWAD240	5000	2210	500	1478	2125	—	M16x200	6
EWAD300	5000	2210	500	1478	2125	—	M16x200	6
EWAD340	5000	2210	500	1478	2125	—	M16x200	6
EWAD380	5906	2210	358.5	1600	2125	1989	M16x200	8
EWAD460	5906	2210	358.5	1600	2125	1989	M16x200	8
EWAD520	5906	2210	358.5	1600	2125	1989	M16x200	8
EWAD600	5906	2210	358.5	1600	2125	1989	M16x200	8

- Make sure that the foundation surface is even and flat.

NOTE



- The measurement tabulated is based on the fact the base is made in the ground (5) or on a concrete floor (6). In case the base is made on a rigid floor, it is possible to include thickness of concrete floor in that of the base.
- In case a base is made on concrete floor, make sure to provide a ditch (7) as shown. It is important to extract drainage regardless of whether a base is made in the ground or on the concrete floor (ditch-sewerage).
- Ingredient ratio of the concrete is: cement 1, sand 2 and gravel 3. Insert iron bars of $\varnothing 10$ mm at every interval of 300 mm. The edge of the concrete base should be planed.

IMPORTANT INFORMATION REGARDING THE REFRIGERANT USED

This product contains fluorinated greenhouse gases covered by the Kyoto Protocol. Do not vent gases into the atmosphere.

Refrigerant type: R134a

GWP⁽¹⁾ value: 1300

⁽¹⁾ GWP = global warming potential

The refrigerant quantity is indicated on the unit name plate.

PREPARING, CHECKING AND CONNECTING THE WATER CIRCUIT

The units are equipped with a water inlet and water outlet for connection to a chilled water circuit. This circuit must be provided by a licensed technician and must comply with all relevant European and national regulations.



If air or dirt gets in the water circuit, problems may occur. Therefore, always take into account the following when connecting the water circuit:

- Use clean pipes only.
- Hold the pipe end downwards when removing burrs.
- Cover the pipe end when inserting it through a wall so that no dust and dirt enter

Before continuing the installation of the unit, check the following:

- As a general rule for this and other units, it is recommended to check the insertion depth of the water temperature sensors into the connection pipes prior to operation (see figure).

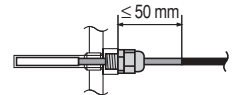

- Connecting a filter



- A filter must be installed in front of the evaporator water inlet (distance <math><0.5\text{ m}</math>). The filter must have holes of diameter ≤ 1.5 mm and secures the evaporator against clogging.
- Improper installation of a filter will result in severe damage of the equipment (freezing of the evaporator).

- Connecting the counter pipes

Weld the supplied counter pipes to the ends of the water circuit and connect to the unit with the provided Victaulic® couplings.

- Drain taps must be provided at all low points of the system to permit complete drainage of the circuit during maintenance or in case of shut down.
- Air vents must be provided at all high points of the system. The vents should be located at points which are easily accessible for servicing.
- Shut-off valves must be provided at the unit so that normal servicing can be accomplished without draining the system.
- Vibration eliminators in all water piping connected to the chiller are recommended to avoid straining the piping and transmitting vibration and noise.
- For units in a DICN configuration with common leaving water control, be sure to provide an insertion hole for the additional water temperature sensor. Sensor and sensor holder are optional parts.

The insertion hole shall be 1/4" GAS female thread and must be located in the mixed water flow of the chillers.

Make sure that the sensor tip is in the water flow and that you have a length of straight pipe (L) of at least 5x the pipe diameter (A) before the sensor.

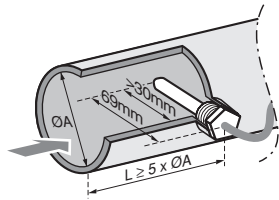

Choose the position of insertion in a way that the cable length of the sensor (12 m) is long enough to be attached to the master PCB.

WATER CHARGE, FLOW AND QUALITY

To assure proper operation of the unit, the water flow through the evaporator must be within the operation range as specified in the table below and a minimum water volume is required in the system.

Model	Minimum water flow	Maximum water flow
EWAD120	150 l/min	490 l/min
EWAD150	200 l/min	725 l/min
EWAD170	200 l/min	725 l/min
EWAD240	300 l/min	930 l/min
EWAD300	395 l/min	1165 l/min
EWAD340	395 l/min	1165 l/min
EWAD380	540 l/min	1580 l/min
EWAD460	640 l/min	1880 l/min
EWAD520	640 l/min	1880 l/min
EWAD600	870 l/min	1880 l/min

The minimum water volume v [l] in the system must fulfill the criteria below:

$$v > (Q/2) \times t / (C \times \Delta T)$$

- Q highest cooling capacity of the unit in lowest capacity step within the range of application (kW)
- t antirecycling timer of unit (AREC)/2(s)=300 s
- C specific heat capacity of the fluidum (kJ/kg°C)=4.186 kJ/kg°C for water
- ΔT temperature difference between starting and stopping of the compressor.
 $\Delta T = a + 2b + c$
 (for designation of a, b and c, refer to the operation manual)



For units in a DICN configuration, the minimum required water volume in the system must equal the biggest required minimum volume of every individual chiller in the system.

The water quality must be in accordance with the specifications listed in the table below.

		circulating water	supply water	tendency if out of criteria
Items to be controlled				
pH	at 25°C	6.8~8.0	6.8~8.0	corrosion+scale
Electrical conductivity	[mS/m] at 25°C	<40	<30	corrosion+scale
Chloride ion	[mg Cl ⁻ /l]	<50	<50	corrosion
Sulfate ion	[mg SO ₄ ²⁻ /l]	<50	<50	corrosion
M-alkalinity (pH4.8)	[mg CaCO ₃ /l]	<50	<50	scale
Total hardness	[mg CaCO ₃ /l]	<70	<70	scale
Calcium hardness	[mg CaCO ₃ /l]	<50	<50	scale
Silica ion	[mg SiO ₂ /l]	<30	<30	scale
Items to be referred to				
Iron	[mg Fe/l]	<1.0	<0.3	corrosion+scale
Copper	[mg Cu/l]	<1.0	<0.1	corrosion
Sulfide ion	[mg S ²⁻ /l]	not detectable	not detectable	corrosion
Ammonium ion	[mg NH ₄ ⁺ /l]	<1.0	<0.1	corrosion
Remaining chloride	[mg Cl/l]	<0.3	<0.3	corrosion
Free carbide	[mg CO ₂ /l]	<4.0	<4.0	corrosion
Stability index		—	—	corrosion+scale



The water pressure must not exceed the maximum working pressure of 10 bar.



Provide adequate safeguards in the water circuit to make sure that the water pressure will never exceed the maximum allowable working pressure.

PIPING INSULATION

The complete water circuit, inclusive all piping, must be insulated to prevent condensation and reduction of the cooling capacity.

Protect the water piping against water freezing during winter period (e.g. by using a heater tape or glycol solution).

FIELD WIRING



All field wiring and components must be installed by a licensed electrician and must comply with relevant European and national regulations.

The field wiring must be carried out in accordance with the wiring diagram supplied with the unit and the instructions given below.

Be sure to use a dedicated power circuit. Never use a power supply shared by another appliance.



Verify on the wiring diagram all electrical actions mentioned below, in order to understand the operation of the unit more deeply.

Parts table

- F1,2,3UMain fuses for the unit
- F4,5UFuses for the evaporator heatertape
- H1PIndication lamp general operation
- H2PIndication lamp alarm
- H3,4PIndication lamp operation circuit 1, circuit 2
- L1,2,3Main terminals
- PEMain earth terminal
- S6SRemote start/stop switch
- S8LFlowswitch
- S9LContact that closes if the pump is working
- S10SSwitch to make selection between setpoint 1 and 2
- S11S,S12SSwitch that disables circuit 1, circuit 2 when closed
- S13SMain isolator switch
- - -Field wiring

Power circuit and cable requirements

- 1 The electrical power supply to the unit must be arranged so that it can be switched on or off independently of the electrical supply to other items of the plant and equipment in general.
- 2 A power circuit must be provided for connection of the unit. This circuit must be protected with the required safety devices, i.e. a circuit breaker, a slow blow fuse on each phase and an earth leak detector. Recommended fuses are mentioned on the wiring diagram supplied with the unit. For a system with chillers in a DICN configuration, be sure to provide a separate power circuit for every chiller.



Switch off the main isolator switch before making any connections (switch off the circuit breaker, remove or switch off the fuses).

Connection of the air-cooled water chiller power supply

- Using the appropriate cable, connect the power circuit to the L1, L2 and L3 terminals of the unit.
In case the option "main isolator switch" is installed on the unit, the power circuit must be connected to the terminals 2,4 and 6 of the main isolator switch.
- Connect the earth conductor (yellow/green) to the earthing terminal PE.

Interconnection cables



A pump interlock contact must be installed **in series with the contact of the flowswitch** to prevent the unit from operating without water flow. A terminal is provided in the switch box for the electrical connection of the interlock contact.

For units in a DICN configuration, every chiller can either have an individual circulation pump or 1 pump can discharge water in a distributor that leads water to several chillers.

In both cases, all units must be equipped with an interlock contact!

NOTE



Normally the unit will not operate if there is no flow thanks to the standard installed flowswitch.

But as to have a double safety, you **must** install the pump interlock contact in series with the contact of the flowswitch.

Operating the unit without flow will result in very severe damage to the unit (freezing of the evaporator).

Heater tape power supply

The evaporator and heat recovery condenser heater tape is supplied with the unit. The heater tape must be connected to an independent supply 1~50 Hz, 230 V and must be connected year-round. Separate fuses have to be installed in the field (refer to the wiring diagram supplied with the unit).

Voltage free contacts

The controller is provided with some voltage free contacts to indicate the status of the unit. These voltage free contacts can be wired as described on the wiring diagram. The maximum allowable current is 4 A.

Remote inputs

Besides the voltage free contacts, there are also possibilities to install remote inputs. They can be installed as shown on the wiring diagram.

For units in DICN configuration, note the following:

- Switch for remote on/off:
Units with status **NORMAL** or **STANDBY** will be controlled by the remote on/off switch connected to the chiller defined as **MASTER**.
Units with status **DISCONNECT ON/OFF** are controlled by the switch connected to them.
See also operation manual: "[Selecting local or remote on/off control](#)".
- Remote dual setpoint switch:
The remote dual setpoint switch may only be connected to the chiller defined as **MASTER**.
However in case the master drops out because of e.g. a power supply failure, it might be interesting to have the dual temperature switch installed to the other units as well.

Connection and setup of a DICN system

(See [Annex I, "Installation examples for a DICN configuration"](#) on page 9)

For a system with chillers in a DICN configuration, the chillers have to be connected as shown in the figure below.

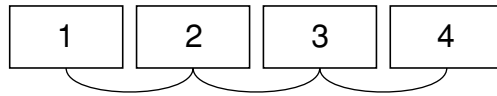

Make the connection as shown on the wiring diagram using an AWG20/22 shielded cable, made up of a twisted pair plus shield.

Pay attention to the polarity! TX+ on one chiller must be connected to TX+ on another chiller. The same for TX- and GND.

Setting the addresses on the digital controller

Set the addresses on the PCB by means of DIP-switches according to the drawing below:



Any unit can be master, slave 1, slave 2, slave 3...

Where to find the DIP-switches of the digital controller

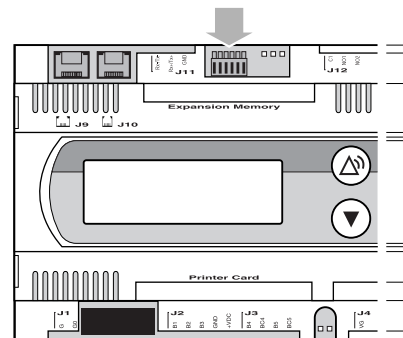

Important

Be sure to attach – in case of common leaving water control – the optional temperature sensor.

Cable for remote digital controller

- A remote digital controller can be connected to the PCB inside the unit by means of a 6-ray cable and a connector located on the rear side of the remote digital controller in case you prefer to operate the unit from a distance. You are allowed to use a cable of up to 600 metres. Specifications of the cable: 6-ray telephone cable with a maximum cable resistance of 0.1 Ω/m.
- For units in a DICN configuration, the remote digital controllers of the units can be installed at a distance of up to 50 metres by using a 6-ray telephone cable with a maximum cable resistance of 0.1 Ω/m.

Setting the addresses on the remote digital controller

When a remote digital controller is used, the address has to be set by means of DIP-switches according to the drawing below:



Any unit can be master, slave 1, slave 2, slave 3...

Where to find the DIP-switches of the remote digital controller

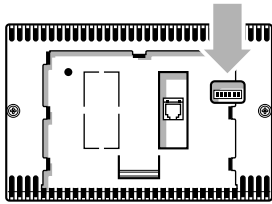

To avoid damage to the controllers liquid crystals during winter time, do not shut off the main power supply.

Setting the addresses on the EEV drivers

When EEV drivers are used, the addresses has to be set by means of DIP-switches according to the drawing below:

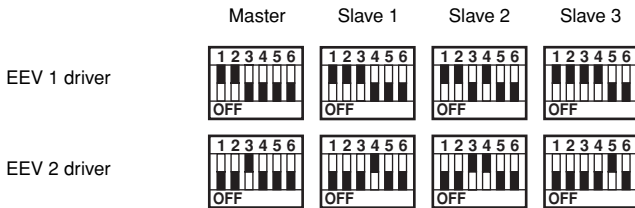

Any unit can be master, slave 1, slave 2, slave 3...

Where to find the DIP-switches of the EEV drivers

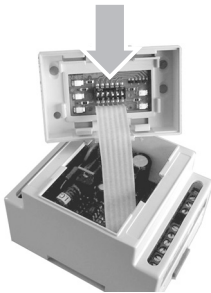

BEFORE STARTING



The unit may not be started, not even for a very short period of time, before the following pre-commissioning checklist is filled out completely.

tick ✓ when checked	standard steps to go through before starting the unit
<input type="checkbox"/> 1	Check for external damage .
<input type="checkbox"/> 2	Open all shut-off valves indicated by a red label: "OPEN THIS VALVE BEFORE OPERATION". (Open the liquid line, discharge and suction (if provided) stop valves completely.)
<input type="checkbox"/> 3	Install main fuses, earth leak detector and main switch . Recommended fuses: aM according to IEC standard 269-2. <i>Refer to the wiring diagram for size.</i>
<input type="checkbox"/> 4	Supply the main voltage and check if it is within the allowable $\pm 10\%$ limits of the nameplate rating. The electrical main power supply must be arranged so, that it can be switched on or off independently of the electrical supply to other items of the plant and equipment in general. <i>Refer to the wiring diagram, terminals L1, L2 and L3.</i>
<input type="checkbox"/> 5	Supply water to the evaporator and verify if water flow is within the limits as given in the table under " Water charge, flow and quality " on page 4.
<input type="checkbox"/> 6	The piping must be completely purged .
<input type="checkbox"/> 7	Connect the pump contact in series with the contact of the flowswitch, so that the unit can only come in operation when the waterpumps are running and the water flow is sufficient. For DICN configurations, every chiller shall have its own flowswitch and shall be interlocked with the pump from which it gets the flow.
<input type="checkbox"/> 8	Check the oil level in the compressors.
<input type="checkbox"/> 9	Connect the power supply to the heater tape . The heater tape must be connected to an independent, separately fused, power supply all year-round.
<input type="checkbox"/> 10	Install a filter in front of the evaporator water inlet.
<input type="checkbox"/> 11	Check that all the water sensors are correctly fixed into the connection pipes of the heat exchanger.

NOTE



- It is necessary to read the operation manual delivered with the unit before operating the unit. It will contribute to understand the operation of the unit and its electronic controller.
- Close all switch box doors after installation of the unit.

I do confirm having executed and checked all the above mentioned items.

Date

Sign

Keep for future reference.

CUSTOMIZATION IN THE SERVICE MENU



All customized settings must be done by a licensed technician.

To change a setting in the service menu:

- 1 Enter the usersettings menu as indicated in the operation manual and press the ∇ key to go to the last screen to enter the service menu (this is only possible if the unit is off).
- 2 Enter the correct password using the ∇ and \blacktriangle keys. The password can be found in the service manual.
- 3 Press \blacktriangle to confirm the password and enter the service menu.
- 4 Go to the screen which contains the parameter to be modified by using the ∇ and \blacktriangle keys.
- 5 Position the cursor behind the parameter to be modified using the \blacktriangle key.
- 6 Select the appropriate setting using the ∇ and \blacktriangle keys.
- 7 Press \blacktriangle to confirm the modification. When the modification has been confirmed, the cursor switches to the next parameter which can now be configured.
- 8 Place the cursor in the top left corner of the screen when you are finished changing the parameters on this screen.
- 9 Repeat from instruction 4 onwards to modify other parameters.

Setting of the minimum outlet water temperature

It is possible to change the minimum outlet water temperature (MIN. OUTWATER) in the service menu. Before lowering the minimum outlet water temperature:

- Make sure that sufficient glycol is added to the water system according to the table.
- Make sure that the low pressure safety is lowered according to the table.

	minimum outlet water (MIN. OUTWATER)			
	2°C	0°C	-5°C	-10°C
Weight of ethylene glycol (%)	10	20	30	40
Weight of propylene glycol (%)	15	25	35	40
Low pressure setting (bar)	0.8	0.6	0.2	0.2



Improper setting of the minimum outlet water temperature can result in severe damage of the equipment.

Defining a unit in a setup of a DICN system

Change the setting of MS OPTION to Y on each unit.

Setting the password for safety reset

To avoid resetting of safeties by unqualified persons, the user password is asked by default when resetting a safety.

This password however can be changed to SERVICE PASSWORD or to NONE.

NOTE



Since inadequate resetting of safeties can damage the machine, it is advised to keep the default setting of USER PASSWORD.

Setting of compressor running hours

When the displayed running hours do not comply with the actual running hours of the compressor it is possible to change the running hours to comply.

Defining of the changeable digital/analog inputs and outputs

Besides locked inputs and outputs there are a number of changeable inputs and outputs of which the function can be chosen from several possibilities.

Possible functions for changeable digital inputs are:

- NONE: no function is appointed to the changeable digital input.
- STATUS: no function is appointed to the changeable digital input, but the input status can be read in the "input/output" menu.
- DUAL SETPOINT: to switch between setpoints.
- REMOTE ON/OFF: to remotely switch the unit on or off.
- CAP. LIM 1/2/3/4: to limit the capacity of the unit to the entered values.

Possible functions for the changeable digital output are:

- NONE (OPEN): no function is appointed to the changeable digital output.
- 1 (CLOSED): no function is appointed to the changeable digital output, but the output is closed.
- 2ND EVAP PUMP: can be used to steer a second evaporator pump.
- 100% CAPACITY: indicates when the unit is working at 100%.
- FREE COOLING: to control a 3-way water valve when the unit is working in free cooling state.

Possible configurations for the changeable analog input are:

- NONE: no function is appointed to the changeable analog input.
- SETP. SIGN. 0/1V:
- SETP. SIGN. 0/10V:
- SETP. SIGN. 0/20mA:
- SETP. SIGN. 4/20mA:

This allows the user to define a setpoint in function of an analog input as mentioned above. Refer to "Defining the setpoint signal setting" on page 7.

- MS OUTL WATER E: to control the leaving water temperature of a DICN system.

Defining the setpoint signal setting

The setpoint signal is used to change the setpoint by an external analog input signal on a stand alone unit or on Slave 1 in a DICN system.

Example

in setpoints menu

```
→ > INLSETP1 E: 12.0°C
    INLSETP2 E: 12.0°C
    OUTLSETP1 E: 07.0°C
    OUTLSETP2 E: 07.0°C
```

in service menu

```
→ ↵ CHANG. INP/OUTPUTS
→ AI1: SETP. SIGN: 0/1V
→ MAX SETP. DIF: 5.0°C
```

Remark: MAX SETP. DIFF is only available when input SETP. SIGN (0/1V, 0/10V, 0/20mA or 4/20mA) is selected.

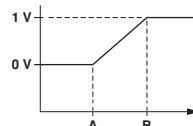

Result

A at 0 V → 12.0°C

B at 1 V → 12.0°C + 5.0°C = 17.0°C

Display in readout menu

INLSETP1 E: 12.0°C

INLSETP1 E: 17.0°C

Setting of the probe offset

It is possible to enter a correction value for certain measured temperatures (inlet water evaporator temperature and mixed outlet water evaporator temperature). This in order to correct a possible measurement fault. The default value of the probe offset, is equal to 0.

Steering the pump manually

There is the possibility to turn the pump on or off manually. This means that when the unit is off the pump can also be turned on at any time to check the pump.

Defining the BMS settings

The BMS parameters allowing communication between the unit and the supervisory system can be modified with the BMS SETTINGS and the BMSBOARD SETTINGS screen of the service menu. The BMS parameters are:

BMS SETTINGS screen:

- BMS CONTROL ALLOWED: if set to Y (yes), the unit can be commanded and configured from a supervisory system. If set to N (no), the supervisory system can only read out values but cannot modify them.
- BMS ADDR.PCB: used to address the PCB.
- PROTOCOL: indicates the communication protocol. If the optional gateway is used to connect the units to a supervisory system, the protocol is CAREL.

BMSBOARD SETTINGS screen:

- SER. BOARD: indicates the type of serial connection. The default is set to RS485.
- BAUD RATE: indicates the speed of communication. The default setting of 19200 bps must be used when the optional gateway is connected.

Defining the thermostat settings

Defining the thermostat settings for inlet and outlet water temperature of a, b and c can only be set in the service menu.

```

┌─STEP┐ SERVICE MENU
└─┬──┘
A:0.8 B:0.5 C:0.2°C
INLDIFF:0.5°C
    
```

To define the thermostat settings of the inlet water temperature.

HOW TO CONTINUE

After installation and connection of the packaged air-cooled water chiller, the complete system must be checked and tested as described in "Checks before initial start-up" in the operation manual supplied with the unit.

Fill out the brief operation instructions form and fix it visibly near the operating site of the refrigeration system.

ANNEX I

Installation examples for a DICN configuration

INTRODUCTION

This annex introduces 3 installation examples to help you set up your Daikin Integrated Chiller Network or DICN configuration.

Defining a unit in a setup of a DICN system

Change the setting of MS_OPTION to Y on each unit.

EXAMPLES

Field wiring and wiring parts table



All field wiring and components must be installed by a licensed electrician and must comply with relevant European and national regulations.

The field wiring must be carried out in accordance with the wiring diagram supplied with the unit and instructions given below.

Be sure to use a dedicated power circuit. Never use a power supply shared by another appliance.

All customized settings must be done by a licensed technician.

.....	Field wiring
.....	Earth wiring
●	Terminal on the unit
F1~F20.....	Fuses
K1P~K4P.....	Pump contact (S9L on main wiring diagram)
L1,L2,L3,N.....	Main supply terminals
M1P~M5P	Pump motor
R8T	Sensor for common leaving water in a DICN system (EKCLWS)
R9T	Sensor for secondary circuit
S1S	Manual switch for pump of master unit
S6S (M,S3).....	Remote start/stop switch
S10S	Dual setpoint selection switch
Y1S	3-way valve

Example 1: Single ring system with 1 pump

Figure 1 shows the system configuration, field wiring and terminals for field wiring of this example.

Purpose	
Purpose of this system is to deliver a constant water flow at a constant temperature to a particular load. One unit, slave 3 (S3), is kept as a standby unit.	
Setup	
■	The system is controlled on leaving water temperature. It is required to install the additional sensor R8T (EKCLWS) in the mixed water outlet and to connect it to the PCB of the master unit.
■	The pump keeps running as long as 1 of the units is ON. After switching OFF all units, the pump runs for a time indicated by the PUMPLAG setting.
■	Slave 3 (S3) is configured to operate when its remote start/stop switch S6S (S3) is pushed by the operator.
■	Slave 1 (S1), slave 2 (S2) and the master unit (M) are switched ON or OFF using the remote start/stop switch S6S (M) which is connected to the master unit.
■	The setpoint can be switched from OUTLETSETP1 to OUTLETSETP2 using the dual setpoint selection switch S10S which is connected to the master unit.
NOTE	
■	K*P can also be a 24 V DC or 230 V AC contactor.
■	The additional sensor R8T (EKCLWS) must be connected directly to the PCB of the master unit.

Parameter settings of the units

Usersettings menu:

	Slave 3	Slave 2	Slave 1	Master
MODE:	DISCONNECT ON/OFF	NORMAL	NORMAL	NORMAL
PUMP ON IF:	UNIT ON	UNIT ON	UNIT ON	UNIT ON

Changeable inputs/outputs must be defined as follows:

Service setting menu:

	Slave 3	Slave 2	Slave 1	Master
Terminal 76-78 S10S DI1	NONE	NONE	NONE	DUAL SETPOINT
Terminal 76-79 S6S DI2	REMOTE ON/OFF	NONE	NONE	REMOTE ON/OFF
Terminal 76-85 DI3	NONE	NONE	NONE	NONE
Terminal 76-86 DI4	NONE	NONE	NONE	NONE
Terminal 8T+8T-R8T AI1	NONE	NONE	NONE	MS OUTL WATER E

Remark

Slave 3 can be configured to start up automatically if:

- 1 of the other units is in alarm or;
- all other units are running on full capacity and the setpoint is not reached yet.

To have your slave 3 unit act this way, set its mode to STANDBY. In this case, S6S (S3) has no function.

Example 2: Single ring system with separate pumps

Figure 2 shows the system configuration, field wiring and terminals for field wiring of this example.

Purpose

Purpose of this system is to deliver a constant water flow at a constant temperature to a particular load. One unit, slave 3 (S3), is kept as a standby unit.

Setup

- The system is controlled on leaving water temperature. It is required to install the additional sensor R8T (EKCLWS) in the mixed water outlet and to connect it to the PCB of the master unit.
- Pump 1, pump 2 and pump 3 keep running as long as the master unit, slave 1 or slave 2 are ON. Pump 4 only starts running if slave 3 is switched ON. After switching OFF the units, the pumps run for a time indicated by the PUMPLAG setting.
- Slave 3 (S3) is configured to operate when its remote start/stop switch S6S (S3) is pushed by the operator.
- Slave 1 (S1), slave 2 (S2) and the master unit (M) are switched ON or OFF using the remote start/stop switch S6S (M) which is connected to the master unit.
- The setpoint can be switched from OUTLETSETP1 to OUTLETSETP2 using the dual setpoint selection switch S10S which is connected to the master unit.

NOTE

- K*P can also be a 24 V DC or 230 V AC contactor.
- The additional sensor R8T (EKCLWS) must be connected directly to the PCB of the master unit.

Parameter settings of the units

Usersettings menu:

	Slave 3	Slave 2	Slave 1	Master
MODE:	DISCONNECT ON/OFF	NORMAL	NORMAL	NORMAL
PUMP ON IF:	UNIT ON	UNIT ON	UNIT ON	UNIT ON

Changeable inputs/outputs must be defined as follows:

Service setting menu:

	Slave 3	Slave 2	Slave 1	Master
Terminal 76-78 S10S DI1	NONE	NONE	NONE	DUAL SETPOINT
Terminal 76-79 S6S DI2	REMOTE ON/OFF	NONE	NONE	REMOTE ON/OFF
Terminal 76-85 DI3	NONE	NONE	NONE	NONE
Terminal 76-86 DI4	NONE	NONE	NONE	NONE
Terminal 8T+8T- R8T AI1	NONE	NONE	NONE	MS OUTL WATER E

Remark

Slave 3 can be configured to start up automatically if:

- 1 of the other units is in alarm or;
- all other units are running on full capacity and the setpoint is not reached yet.

To have your slave 3 unit act this way, set its mode to STANDBY. In this case, S6S (S3) has no function.

Example 3: Double ring system with several pumps

Figure 3 shows the system configuration, field wiring and terminals for field wiring of this example.

Purpose

Purpose of this system is to keep a buffer at a constant temperature and to feed a load from this buffer. One unit, slave 3 (S3), is kept as a standby unit.

Setup

- The system is controlled on entering water temperature.
- The pumps of the slave units only run when their compressor is running (energy saving). After stopping the compressor, the pump runs for a time indicated by the PUMPLAG setting.
- The pump of the master unit must run continuously so as to sense the correct temperature.
- Slave 3 (S3) is configured to operate when its remote start/stop switch S6S (S3) is pushed by the operator.
- Slave 1 (S1), slave 2 (S2) and the master unit (M) are switched ON or OFF using the remote start/stop switch S6S (M) which is connected to the master unit.
- The setpoint can be switched from INLETSETP1 to INLETSETP2 using the dual setpoint selection switch S10S which is connected to the master unit.

NOTE

K*P can also be a 24 V DC or 230 V AC contactor.



Parameter settings of the units

Usersettings menu:

	Slave 3	Slave 2	Slave 1	Master
MODE:	DISCONNECT ON/OFF	NORMAL	NORMAL	NORMAL
PUMP ON IF:	COMPR ON	COMPR ON	COMPR ON	COMPR ON

Changeable inputs/outputs must be defined as follows:

Service setting menu:

	Slave 3	Slave 2	Slave 1	Master
Terminal 76-78 S10S DI1	NONE	NONE	NONE	DUAL SETPOINT
Terminal 76-79 S6S DI2	REMOTE ON/OFF	NONE	NONE	REMOTE ON/OFF
Terminal 76-85 DI3	NONE	NONE	NONE	NONE
Terminal 76-86 DI4	NONE	NONE	NONE	NONE
Terminal 8T+8T- R8T AI1	NONE	NONE	NONE	NONE

Remark

Slave 3 can be configured to start up automatically if:

- 1 of the other units is in alarm or;
- all other units are running on full capacity and the setpoint is not reached yet.

To have your slave 3 unit act this way, set its mode to STANDBY. In this case, S6S (S3) has no function.

BRIEF OPERATION INSTRUCTIONS

EWAD-MBYNN Packaged air-cooled water chillers

Equipment supplier: _____

Service department: _____

.....

.....

Phone:.....

Phone:.....

EQUIPMENT TECHNICAL DATA

Manufacturer	: DAIKIN EUROPE	Power supply (V/Ph/Hz/A)	:
Model	:	Maximum high pressure	:20 bar
Serial Number	:	Charging weight (kg) R134a	:
Year of construction	:		

START-UP AND SHUT DOWN

- Start-up by switching on the circuit breaker of the power circuit. The operation of the water chiller is then controlled by the Digital Display Controller.
- Shut-down by switching off the controller and the circuit breaker of the power circuit.

WARNINGS

Emergency shut down : Switch off the **circuit breaker** located on

.....

.....

Air inlet and outlet : Always keep the air inlet and outlet free to obtain the maximum cooling capacity and to prevent damage to the installation.

Refrigerant charge : Use refrigerant R134a only.

First aid : In case of injuries or accidents immediately inform:



- **Company management** : Phone
- **Emergency physician** : Phone
- **Fire service** : Phone



