SPLIT SYSTEM**Air Conditioner**

MODELS
(Floor standing type)

FVQ71BV1B
FVQ100BV1B
FVQ125BV1B

English

Deutsch

Français

Español

Italiano

Ελληνικά

Nederlands

Portugues

Русский

Türkçe

Thank you for purchasing this Daikin air conditioner.

Carefully read this operation manual before using the air conditioner. It will tell you how to use the unit properly and help you if any trouble occurs. After reading the manual, file it away for future reference.

Vielen Dank für den Kauf einer Klimaanlage von Daikin.

Lesen Sie dieses Betriebshandbuch vor Inbetriebnahme der Klimaanlage sorgfältig durch. Sie erfahren hier, wie die Einheit korrekt genutzt wird, und es ist Ihnen bei Störungen behilflich. Wenn Sie das Handbuch durchgelesen haben, bewahren Sie es gut auf, damit Sie auch später noch nachschlagen können.

Nous vous remercions pour votre acquisition de ce système de climatisation Daikin.

Lisez attentivement ce manuel avant d'utiliser le climatiseur. Il vous expliquera comment vous servir correctement de l'appareil et vous guidera en cas de problème. Lorsque vous aurez lu le manuel, rangez-le afin de pouvoir vous y référer ultérieurement.

Le agradecemos la compra de este acondicionador de aire Daikin.

Lea cuidadosamente el manual de funcionamiento antes de utilizar el acondicionador de aire. Dicho manual le indicará cómo utilizar adecuadamente la máquina y le ayudará en caso de avería. Después de leer el manual, consérvelo para consultas futuras.

La ringraziamo di aver acquistato questo condizionatore d'aria Daikin

Leggere attentamente questo manuale prima di utilizzare il condizionatore. Contiene le istruzioni per usare correttamente l'unità e per rimediare ad eventuali problemi di funzionamento. Dopo averlo letto, conservare il manuale per consultazioni future.

Σας ευχαριστούμε που αγοράσατε αυτή την κλιματιστική συσκευή της Daikin.

Διαβάστε προσεκτικά αυτό το εγχειρίδιο χρήσης πριν χρησιμοποιήσετε την κλιματιστική συσκευή. Θα σας εξηγήσει πως να χρησιμοποιείτε τη μονάδα σωστά και θα σας βοηθήσει αν παρουσιαστεί κάποιο πρόβλημα. Αφού διαβάσετε το εγχειρίδιο, φυλάξτε το για μελλοντική χρήση.

Wij danken u voor de aankoop van deze Daikin-airconditioner.

Lees deze bedrijfshandleiding aandachtig door voordat u de airconditioner gebruikt. Het omvat uitleg over het correcte gebruik van de unit en biedt hulp in geval een storing mocht optreden. Gebruik deze handleiding voor verdere raadpleging.

Obrigado pela sua compra deste aparelho de ar condicionado Daikin.

Leia com atenção este manual de operação antes de proceder à utilização do aparelho de ar condicionado. Este indicará-lhe como deverá utilizar a unidade correctamente e ajudá-lo-á no caso de surgir qualquer problema. Depois de ler o manual, guarde-o a fim de o poder consultar caso venha a ser preciso.

Благодарим за покупку кондиционера Daikin. До начала работы с кондиционером внимательно изучите данное руководство по эксплуатации. В нем излагаются правила пользования и приводятся рекомендации по поиску и устранению неисправностей. После изучения руководства сохраните его для справки.

Daikin klima satın aldığınız için teşekkür ederiz.

Klimanızı kullanmadan önce bu kullanma kılavuzunu dikkatlice okuyunuz. Bu kılavuz ünitenin nasıl uygun olarak kullanılacağını anlatır ve herhangi bir problem olduğunda size yardım eder. Kullanma kılavuzunu okuduktan sonra ileride tekrar faydalanmak üzere saklayınız.

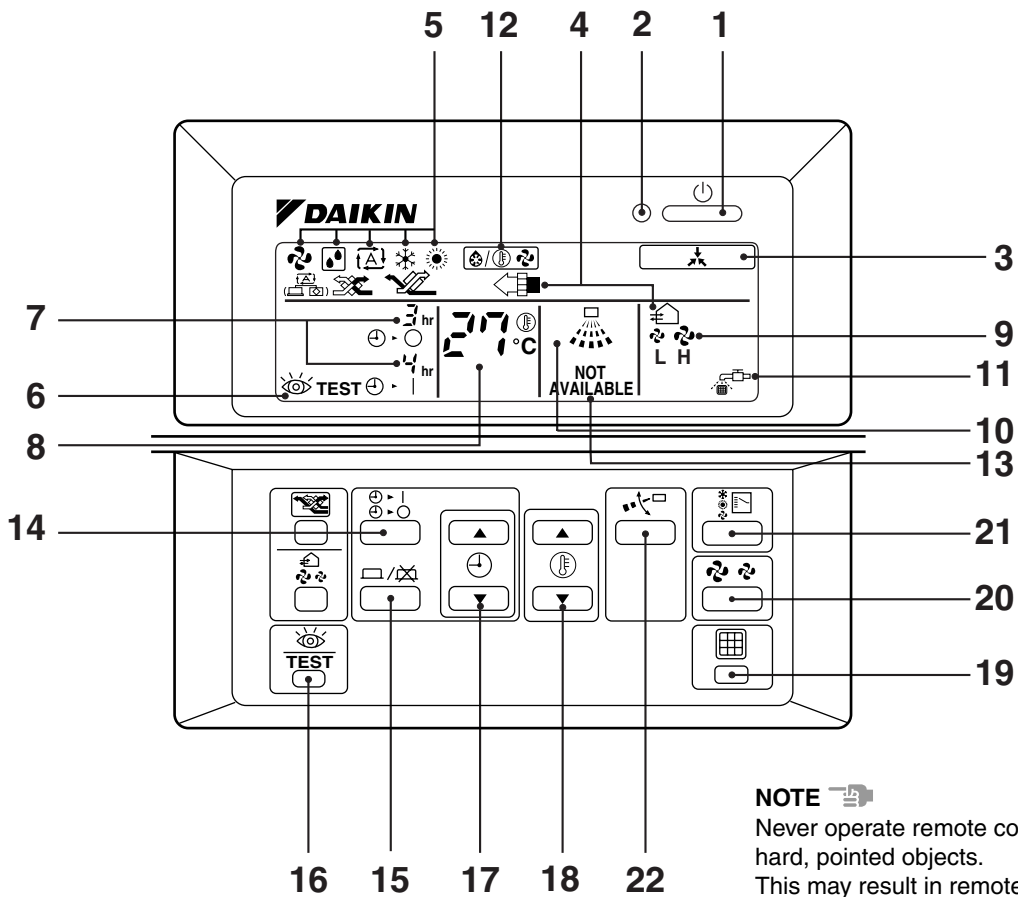

NOTE  Never operate remote controller buttons with hard, pointed objects. This may result in remote controller damage.

1

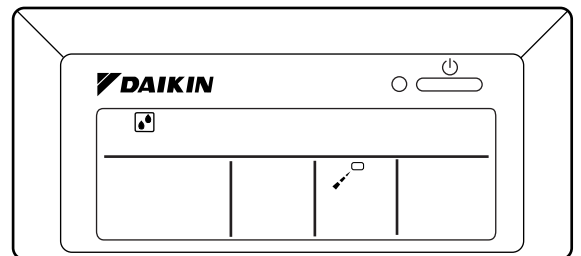
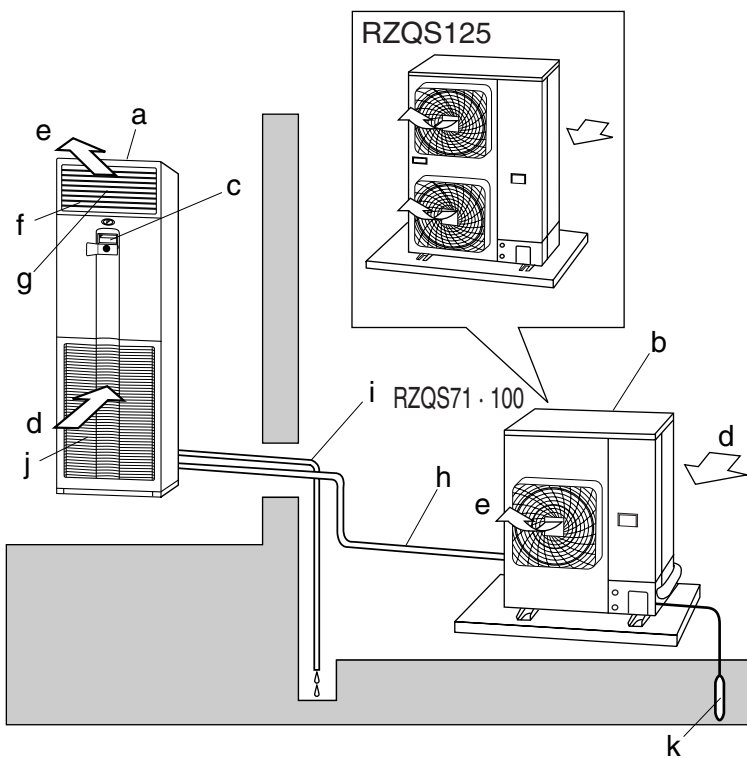

3

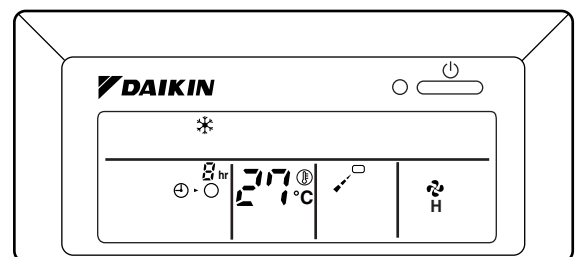

2

4

■ DISPOSAL REQUIREMENTS ■ VORSCHRIFTEN ZUR ENTSORGUNG ■ INSTRUCTIONS D'ÉLIMINATION
■ REQUISITOS PARA LA ELIMINACIÓN ■ SPECIFICHE DI SMALTIMENTO ■ ΠΡΟΫΠΟΘΕΣΕΙΣ ΑΠΟΡΡΙΨΗΣ
■ VEREISTEN VOOR HET OPRUIJEN ■ REQUISITOS PARA A ELIMINAÇÃO

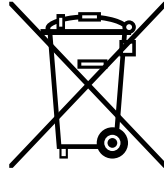

GB Disposal requirements

Your air conditioning product is marked with this symbol. This means that electrical and electronic products shall not be mixed with unsorted household waste.

Do not try to dismantle the system yourself: the dismantling of the air conditioning system, treatment of the refrigerant, of oil and of other parts must be done by a qualified installer in accordance with relevant local and national legislation.

Air conditioners must be treated at a specialized treatment facility for re-use, recycling and recovery. By ensuring this product is disposed of correctly, you will help to prevent potential negative consequences for the environment and human health. Please contact the installer or local authority for more information.

Batteries must be removed from the remote controller and disposed of separately in accordance with relevant local and national legislation.

D Vorschriften zur Entsorgung

Ihre Klimaanlage ist mit diesem Symbol gekennzeichnet. Das bedeutet, dass elektrische und elektronische Produkte nicht mit unsortiertem Haushaltsabfall entsorgt werden dürfen.

Versuchen Sie auf keinen Fall das System selbst zu demontieren. Die Demontage des Klimaanlage-Systems sowie die Handhabung von Kältemittel, Öl und möglichen weiteren Teilen muss von einem qualifizierten Monteur gemäß den entsprechenden örtlichen und staatlichen Bestimmungen vorgenommen werden.

Klimaanlagen müssen bei einer fachkundigen Einrichtung für Wiederverwendung, Recycling und Wiedergewinnung aufbereitet werden. Indem Sie dieses Produkt korrekt entsorgen, helfen Sie potenzielle negative Folgen für die Umwelt und die Gesundheit der Menschen zu vermeiden. Nehmen Sie bitte hinsichtlich weiterer Informationen Kontakt auf mit dem Monteur oder den örtlichen Behörden.

Die Batterien müssen aus der Fernbedienung entfernt werden und gemäß den entsprechenden örtlichen und staatlichen Vorschriften separat entsorgt werden.

F Instructions d'élimination

Cet appareil de conditionnement d'air porte le symbole ci-joint. Ce symbole signifie que les appareils électriques et électroniques doivent être éliminés séparément des ordures ménagères non triées.

N'essayez pas de démonter vous-même l'appareil : le démontage de l'appareil de conditionnement d'air ainsi que le traitement du réfrigérant, de l'huile et d'autres composants doivent être effectués par un installateur qualifié, en accord avec les réglementations locales et nationales en vigueur.

Les appareils de conditionnement d'air doivent être traités dans des installations spécialisées de dépannage, réutilisation ou recyclage. En vous assurant que cet appareil est éliminé correctement, vous contribuez à éviter les conséquences potentiellement néfastes sur l'environnement et la santé. Veuillez contacter votre installateur ou les autorités locales pour plus d'information.

Les piles de la télécommande doivent être enlevées et éliminées séparément, conformément aux réglementations locales et nationales en vigueur.

E Requisitos para la eliminación

Su acondicionador de aire está marcado con este símbolo. Esto significa que los productos eléctricos y electrónicos no deben mezclarse con el resto de residuos domésticos no clasificados.

No intente desmontar el sistema usted mismo: El desmantelamiento del acondicionador de aire, así como el tratamiento del refrigerante, aceite y otros componentes, debe ser efectuado por un instalador competente de acuerdo con las normas locales y nacionales aplicables.

Los acondicionadores de aire deben ser tratados en instalaciones especializadas para su reutilización, reciclaje y recuperación. Al asegurarse de desmontar este producto de la forma correcta, está contribuyendo a evitar posibles consecuencias negativas para el entorno y para la salud de las personas. Contacte, por favor, con el instalador o con las autoridades locales para obtener más información.

Las pilas del control remoto deben extraerse y eliminarse por separado y de acuerdo con la normativa local y nacional aplicable.

I Specifiche di smaltimento

Il climatizzatore è contrassegnato con questo simbolo, ciò significa che i prodotti elettrici ed elettronici non possono essere smaltiti insieme ai rifiuti domestici non differenziati.

Non cercare di demolire il sistema da soli: la demolizione del sistema di condizionamento, nonché il recupero del refrigerante, dell'olio e di qualsiasi altra parte devono essere eseguiti da un installatore qualificato in conformità alla legislazione locale e nazionale vigente in materia.

I climatizzatori devono essere trattati presso una struttura specializzata nel riutilizzo, riciclaggio e recupero dei materiali. Il corretto smaltimento del prodotto eviterà le possibili conseguenze negative all'ambiente e alla salute dell'uomo. Per maggiori informazioni contattare l'installatore o le autorità locali.

Le batterie devono essere tolte dal telecomando e smaltite separatamente conformemente alla legislazione locale e nazionale vigente in materia.

GR Προϋποθέσεις απόρριψης

Το κλιματιστικό σας επισημαίνεται με αυτό το σύμβολο. Αυτό σημαίνει ότι οι ηλεκτρικές και ηλεκτρονικές συσκευές πρέπει να απορρίπτονται χωριστά από τα οικιακά απορρίμματα.

Μην προσπαθήσετε να αποσυναρμολογήσετε μόνοι σας το σύστημα: Η αποσυναρμολόγηση της μονάδας κλιματισμού, ο χειρισμός του ψυκτικού μέσου, του λαδιού και των άλλων μερών θα πρέπει να γίνεται από κάποιο ειδικευμένο τεχνικό, σύμφωνα με τη σχετική τοπική και εθνική νομοθεσία. Για την εκ νέου χρήση, την ανακύκλωση και την επισκευή, οι μονάδες κλιματισμού θα πρέπει να υφίστανται επεξεργασία σε ειδικές εγκαταστάσεις. Επιβεβαιώνοντας ότι αυτό το προϊόν απορρίπτεται σωστά, θα αποφύγετε ενδεχόμενες αρνητικές συνέπειες για το περιβάλλον και την υγεία. Παρακαλούμε επικοινωνήστε με τον τεχνικό εγκατάστασης ή τις τοπικές αρχές για περισσότερες πληροφορίες.

Οι μπαταρίες θα πρέπει να αφαιρούνται από το τηλεχειριστήριο και να απορρίπτονται ξεχωριστά, σύμφωνα με τη σχετική τοπική και εθνική νομοθεσία.

NL Vereisten voor het opruimen

Uw airconditioningproduct draagt dit symbool. Dit betekent dat u geen elektrische en elektronische producten mag mengen met niet-gesorteerd huishoudelijk afval.

Probeer niet zelf het systeem te ontmantelen: het ontmantelen van het airconditioningsysteem, behandelen van het koelmiddel, olie en andere onderdelen moet worden uitgevoerd door een bevoegd installateur in overeenstemming met de relevante lokale en nationale reglementeringen. Airconditioners moeten bij een gespecialiseerd behandelingsbedrijf worden behandeld voor hergebruik, recyclage en terugwinning. Door ervoor te zorgen dat dit product op de correcte manier wordt opgeruimd, helpt u potentiële negatieve gevolgen voor het milieu en de gezondheid te voorkomen. Voor meer informatie, gelieve contact op te nemen met de installateur of de lokale overheid.

De batterijen moeten uit de afstandsbediening worden verwijderd en afzonderlijk opgeruimd in overeenstemming met de relevante lokale en nationale reglementeringen.

P Requisitos para a eliminação

O equipamento de ar condicionado que possui está marcado com este símbolo. Significa que os produtos eléctricos e electrónicos não devem ser misturados com o lixo doméstico indiferenciado.

Não tente desmontar pessoalmente o sistema: o desmantelamento do sistema de ar condicionado e o tratamento do líquido de refrigeração, do óleo e de outros componentes têm de ser feitos por um instalador qualificado, cumprindo a legislação nacional relevante e regulamentos locais aplicáveis.

Os equipamentos de ar condicionado têm de ser processados numa estação de tratamento especializada, para reutilização, reciclagem ou recuperação. Ao certificar-se de que este produto é eliminado correctamente, está a contribuir para evitar as potenciais consequências negativas para o ambiente e para a saúde humana. Contacte o seu instalador ou as autoridades locais, para obter mais informações.

As pilhas do controlo remoto têm de ser retiradas e eliminadas separadamente, cumprindo a legislação nacional e os regulamentos locais aplicáveis.

CONTENTS

ILLUSTRATION..... [1]	
1. WHAT TO DO BEFORE OPERATION	1
2. SAFETY PRECAUTIONS	1
3. OPERATION RANGE	4
4. INSTALLATION SITE	4
5. NAME AND FUNCTION OF EACH SWITCH AND DISPLAY ON THE CONTROL PANEL.....	4
6. OPERATION PROCEDURE	5
7. OPTIMUM OPERATION	7
8. MAINTENANCE (FOR SERVICE PERSONNEL)	8
9. NOT MALFUNCTION OF THE AIR CONDITIONER.....	9
10. TROUBLE SHOOTING.....	10

Important information regarding the refrigerant used

This product contains fluorinated greenhouse gases covered by the Kyoto Protocol.

Refrigerant type:R410A

GWP⁽¹⁾ value:1975

⁽¹⁾ GWP = global warming potential

Periodical inspections for refrigerant leaks may be required depending on European or local legislation. Please contact your local dealer for more information.

1. WHAT TO DO BEFORE OPERATION

This operation manual is for the following systems with standard control. Before initiating operation, contact your Daikin dealer for the operation that corresponds to your system.

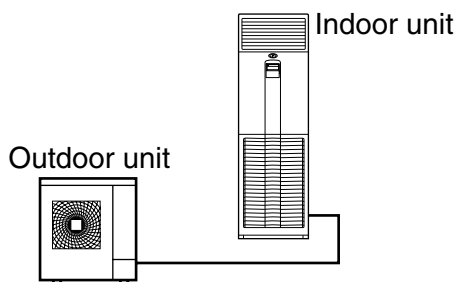

If your installation has a customized control system, ask your Daikin dealer for the operation that corresponds to your system.

- Heat pump type
This system provides cooling, heating, automatic, program dry, and fan operation modes.
- Straight cooling type
This system provides cooling, program dry, and fan operation modes.

PRECAUTIONS FOR GROUP CONTROL SYSTEM OR TWO REMOTE CONTROLLER CONTROL SYSTEM

This system provides two other control systems beside individual control (one control panel controls one indoor unit) system. Confirm the following if your unit is of the following control system type.

- **Group control system**
One control panel controls up to 16 indoor units. All indoor units are equally set.
- **Two remote controller system**
One control panel and one remote controller control one indoor unit (In case of group control system, one group of indoor units)
The unit is individually operated.

NOTE

- Contact your Daikin dealer in case of changing the combination or setting of group control and two remote controller control systems.

Names and functions of parts

Refer to figure 2 on page [1]

a	Indoor unit
b	Outdoor unit
c	Control panel
d	Inlet air
e	Discharged air
f	Air outlet
g	Blade (at air outlet)
h	Refrigerant piping, connection electric wire
i	Drain pipe
j	Air inlet The built-in air filter removes dust and dirt.
k	Ground wire Wire to ground from the outdoor unit to prevent electrical shocks.

NOTE

- The control panel lid opens to around 100 degrees. Opening it further than that may cause it to break or come off the hinges.

2. SAFETY PRECAUTIONS

To gain full advantage of the air conditioner's functions and to avoid malfunction due to mishandling, we recommend that you read this instruction manual carefully before use.

This air conditioner is classified under "appliances not accessible to the general public".

- The precautions described herein are classified as **WARNING** and **CAUTION**. They both contain important information regarding safety. Be sure to observe all precautions without fail.

⚠ WARNING ...Failure to follow these instructions properly may result in personal injury or loss of life.

⚠ CAUTION ...Failure to observe these instructions properly may result in property damage or personal injury, which may be serious depending on the circumstances.

- After reading, keep this manual in a convenient place so that you can refer to it whenever necessary. If the equipment is transferred to a new user, be sure also to hand over the manual.

⚠ WARNING

Be aware that prolonged, direct exposure to cool or warm air from the air conditioner, or to air that is too cool or too warm can be harmful to your physical condition and health.

When the air conditioner is malfunctioning (giving off a burning odour, etc.) turn off power to the unit and contact your local dealer.

Continued operation under such circumstances may result in a failure, electric shocks or fire hazards.

Consult your local dealer about installation work.

Doing the work yourself may result in water leakage, electric shocks or fire hazards.

Consult your local dealer regarding modification, repair and maintenance of the air conditioner.

Improper workmanship may result in water leakage, electric shocks or fire hazards.

Do not place objects, including rods, your fingers, etc., in the air inlet or outlet.

Injury may result due to contact with the air conditioner's highspeed fan blades.

Beware of fire in case of refrigerant leakage.

If the air conditioner is not operating correctly, i.e. not generating cool or warm air, refrigerant leakage could be the cause. Consult your dealer for assistance. The refrigerant within the air conditioner is safe and normally does not leak. However, in the event of a leakage, contact with a naked burner, heater or cooker may result in generation of noxious gas. Do not longer use the air conditioner until a qualified service person confirms that the leakage has been repaired.

Consult your local dealer regarding what to do in case of refrigerant leakage.

When the air conditioner is to be installed in a small room, it is necessary to take proper measures so that the amount of any leaked refrigerant does not exceed the concentration limit in the event of a leakage. Otherwise, this may lead to an accident due to oxygen depletion.

Contact professional personnel about attachment of accessories and be sure to use only accessories specified by the manufacturer. If a defect results from your own workmanship, it may result in water leaks, electric shock or fire.

Consult your local dealer regarding relocation and reinstallation of the air conditioner. Improper installation work may result in leakage, electric shocks or fire hazards.

Be sure to use fuses with the correct ampere reading.

Do not use improper fuses, copper or other wires as a substitute, as this may result in electric shock, fire, injury or damage to the unit.

Be sure to earth the unit.

Do not earth the unit to a utility pipe, lightning conductor or telephone earth lead.

Imperfect earthing may result in electric shocks or fire.

A high surge current from lightning or other sources may cause damage to the air conditioner.

Be sure to install an earth leakage breaker.

Failure to install an earth leakage breaker may result in electric shocks or fire.

Consult the dealer if the air conditioner submerges owing to a natural disaster, such as a flood or typhoon.

Do not operate the air conditioner in that case, or otherwise a malfunction, electric shock, or fire may result.

Do not start or stop operating the air conditioner with the power supply breaker turned ON or OFF.

Otherwise, fire or water leakage may result. Furthermore, the fan will rotate abruptly if power failure compensation is enabled, which may result in injury.

Do not use the product in the atmosphere contaminated with oil vapor, such as cooking oil or machine oil vapor.

Oil vapor may cause crack damage, electric shocks, or fire.

Do not use the product in places with excessive oily smoke, such as cooking rooms, or in places with flammable gas, corrosive gas, or metal dust.

Using the product in such places may cause fire or product failures.

Do not use flammable materials (e.g., hair-spray or insecticide) near the product.

Do not clean the product with organic solvents such as paint thinner.

The use of organic solvents may cause crack damage to the product, electric shocks, or fire.

Be sure to use a dedicated power supply for the air conditioner.

The use of any other power supply may cause heat generation, fire, or product failures.

⚠ CAUTION

Do not use the air conditioner for purposes other than those for which it is intended.

Do not use the air conditioner for cooling precision instruments, food, plants, animals or works of art as this may adversely affect the performance, quality and/or longevity of the object concerned.

Do not remove the outdoor unit's fan guard.

The guard protects against the unit's high speed fan, which may cause injury.

To avoid oxygen depletion, ensure that the room is adequately ventilated if equipment such as a burner is used together with the air conditioner.

After prolonged use, check the unit stand and its mounts for damage.

If left in a damaged condition, the unit may fall and cause injury.

Do not place flammable sprays or operate spray containers near the unit as this may result in fire.

Do not put flammable containers, such as spray cans, within 1 m from the blow-off mouth.

The containers may explode because the warm air output of the indoor or outdoor unit will affect them.

Before cleaning, be sure to stop unit operation, turn the breaker off or remove the power cord. Otherwise, an electric shock and injury may result.

To avoid electric shocks, do not operate with wet hands.

Do not place objects that are susceptible to moisture directly beneath the indoor or outdoor units.

Under certain conditions, condensation on the main unit or refrigerant pipes, air filter dirt or drain blockage may cause dripping, resulting in fouling or failure of the object concerned.

Do not place appliances that produce naked flames in places exposed to the air flow from the unit as this may impair combustion of the burner.

Do not place heaters directly below the unit, as resulting heat can cause deformation.

Do not allow a child to mount on the outdoor unit or avoid placing any object on it. Falling or tumbling may result in injury.

Be sure that children, plants or animals are not exposed directly to airflow from the unit, as adverse effects may ensue.

Do not wash the air conditioner with water, as this may result in electric shocks or fire.

Do not place water containers (flower vases, etc.) on the unit, as this may result in electric shocks or fire.

Do not install the air conditioner at any place where there is a danger of flammable gas leakage.

In the event of a gas leakage, build-up of gas near the air conditioner may result in fire hazards.

Arrange the drain to ensure complete drainage.

If proper drainage from the outdoor drain pipe does not occur during air conditioner operation, there could be a blockage due to dirt and debris build-up in the pipe.

This may result in a water leakage from the indoor unit. Under these circumstances, stop air conditioner operation and consult your dealer for assistance.

The appliance is not intended for use by unattended young children or infirm persons.

Impairment of bodily functions and harm to health may result.

Children should be supervised to ensure that they do not play with the unit or its remote controller.

Accidental operation by a child may result in impairment of bodily functions and harm health.

Consult your dealer regarding cleaning the inside of the air conditioner.

Improper cleaning may cause breakage of plastic parts, water leakage and other damage as well as electric shocks.

To avoid injury, do not touch the air inlet or aluminium fins of the unit.

Do not place objects in direct proximity of the outdoor unit and do not let leaves and other debris accumulate around the unit.

Leaves are a hotbed for small animals which can enter the unit. Once in the unit, such animals can cause malfunctions, smoke or fire when making contact with electrical parts.

Do not block air inlets nor outlets.

Impaired air flow may result in insufficient performance or trouble.

Do not let children play on or around the outdoor unit.

If they touch the unit carelessly, injury may be caused.

Never touch the internal parts of the control panel.

Do not remove the front panel. Touching certain internal parts will cause electric shocks and damage to the unit. Please consult your dealer about checking and adjustment of internal parts.

Do not leave the control panel wherever there is a risk of wetting.

If water gets into the remote controller there is a risk of electrical leakage and damage to electronic components.

3. OPERATION RANGE

If the temperature or the humidity is beyond the following conditions, safety devices may work and the air conditioner may not operate, or sometimes, water may drop from the indoor unit.

COOLING [°C]

OUTDOOR UNIT	INDOOR		OUTDOOR TEMPERATURE
	TEMPERATURE	HUMIDITY	
RZQS71 · 100 · 125	D B	18 to 37	80% or below
	W B	12 to 28	
	D B		-15 to 50

HEATING [°C]

OUTDOOR UNIT	INDOOR TEMPERATURE		OUTDOOR TEMPERATURE
RZQS71 · 100 · 125	D B	10 to 27	D B -19.5 to 21
	W B		-20 to 15.5

DB: Dry bulb temperature

WB: Wet bulb temperature

The setting temperature range of the control panel is 16°C to 32°C.

4. INSTALLATION SITE

Regarding places for installation

- **Is the air conditioner installed at a well-ventilated place where there are no obstacles around?**
- **Ensure that the remote controller is not exposed to direct sunlight.**
This will cause discoloration of the LCD display with resulting loss of readability.
- **Do not use the air conditioner in the following places.**
 - a. Filled with much mineral oil such as cutting oil
 - b. Where there is much salt such as a beach area
 - c. Where sulfured gas exists such as a hot-spring resort
 - d. Where there are considerable voltage fluctuations such as a factory or plant
 - e. Vehicles and vessels
 - f. Where there is much spray of oil and vapor such as a cookery, etc.
 - g. Where there are machines generating electromagnetic waves
 - h. Filled with acid and/or alkaline steam or vapor
- **Is a snow protection measure taken?**
For details, consult your dealer.

Regarding wiring

- **All wiring must be performed by an authorized electrician.**
To do wiring, ask your dealer. Never do it by yourself.
- **Make sure that a separate power supply circuit is provided for this air conditioner and that all electrical work is carried out by qualified personnel according to local laws and regulations.**

Pay attention to running noises, too

- **Are the following places selected?**
 - a. A place that can sufficiently withstand the weight of the air conditioner with less running noises and vibrations.
 - b. A place where the hot wind discharged from the air outlet of the outdoor unit and the running noises do not bother your neighbors.
- **Are you sure that there are no obstacles near the air outlet of the outdoor unit?**
Such obstacles may result in declined performance and increased running noises.
- **If abnormal noises occur in use, consult your dealer.**









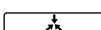

Regarding drainage of drain piping

- **Is the drain piping executed to perform complete drainage?**
If proper drainage is not carried out from the outdoor drain pipes during air-conditioning operation, chances are that dust and dirt are clogged in the pipe. This may result in a water leakage from the indoor unit. Under such circumstances, stop the operation of the air conditioner, and then consult your dealer or our service station.

5. NAME AND FUNCTION OF EACH SWITCH AND DISPLAY ON THE CONTROL PANEL

Refer to figure 1 on page [1]

1	ON/OFF BUTTON
	Press the button and the system will start. Press the button again and the system will stop.
2	OPERATION LAMP (RED)
	The lamp lights up during operation.
3	DISPLAY “” (UNDER CENTRALIZED CONTROL)
	When this display shows, the system is UNDER CENTRALIZED CONTROL. (This is not a standard specification.)

4	DISPLAY “” (VENTILATION/AIR CLEANING)
	This display shows that the total heat exchange and the air cleaning unit are in operation (These are optional accessories).
5	DISPLAY “” (OPERATION MODE)
	This display shows the current OPERATION MODE. For straight cooling type, “  ” (Auto) and “  ” (Heating) are not installed.
6	DISPLAY “” (INSPECTION/TEST OPERATION)
	When the INSPECTION/TEST OPERATION BUTTON is pressed, the display shows the system mode is in.
7	DISPLAY “” (PROGRAMMED TIME)
	This display shows the PROGRAMMED TIME of the system start or stop.
8	DISPLAY “” (SET TEMPERATURE)
	This display shows the set temperature.
9	DISPLAY “” (FAN SPEED)
	This display shows the set fan speed.
10	DISPLAY “” (AIR FLOW FLAP)
	Refer to “ADJUSTING THE AIR FLOW DIRECTION”.
11	DISPLAY “” (TIME TO CLEAN AIR FILTER)
	Refer to “HOW TO CLEAN THE AIR FILTER”.
12	DISPLAY “” (DEFROST)
	Refer to “DEFROST OPERATION”.
13	NON-FUNCTIONING DISPLAY
	If that particular function is not available, pressing the button may display the words “NOT AVAILABLE” for a few seconds. When running multiple units simultaneously The “NOT AVAILABLE” message will only be appear if none of the indoor units is equipped with the function. If even one unit is equipped with the function, the display will not appear.
14	TIMER MODE START/STOP BUTTON
	Refer to “PROGRAM TIMER OPERATION”.
15	TIMER ON/OFF BUTTON
	Refer to “PROGRAM TIMER OPERATION”.
16	INSPECTION/TEST OPERATION BUTTON
	This button is used only by qualified service persons for maintenance purposes.
17	PROGRAMMING TIME BUTTON
	Use this button for programming “START and/or STOP” time.

18	TEMPERATURE SETTING BUTTON
	Use this button for SETTING TEMPERATURE.
19	FILTER SIGN RESET BUTTON
	Refer to “HOW TO CLEAN THE AIR FILTER”.
20	FAN SPEED CONTROL BUTTON
	Press this button to select the fan speed, HIGH or LOW, of your choice.
21	OPERATION MODE SELECTOR BUTTON
	Press this button to select OPERATION MODE.
22	AIR FLOW DIRECTION ADJUST BUTTON
	Refer to “ADJUSTING THE AIR FLOW DIRECTION”.
NOTE 	
<ul style="list-style-type: none"> For the sake of explanation, all indications are shown on the display in Figure 1 contrary to actual running situations. 	

6. OPERATION PROCEDURE

Refer to figure 1 on page [1]



- Operating procedure varies with heat pump type and cooling only type. Contact your Daikin dealer to confirm your system type.
- To protect the unit, turn on the main power switch 6 hours before operation.
- If the main power supply is turned off during operation, operation will restart automatically after the power turns back on again.

COOLING, HEATING, AUTOMATIC, FAN, AND PROGRAM DRY OPERATION

Operate in the following order.

1 OPERATION MODE SELECTOR

Press **OPERATION MODE SELECTOR** button several times and select the **OPERATION MODE** of your choice as follows.

- COOLING OPERATION “”
- HEATING OPERATION “”
- AUTOMATIC OPERATION..... “”

- In this operation mode, COOL/HEAT changeover is automatically conducted.

- FAN OPERATION “”
- PROGRAM DRY OPERATION “”

- The function of this program is to decrease the humidity in your room with the minimum temperature decrease.

- Micro computer automatically determines TEMPERATURE and FAN SPEED.
- This system does not go into operation if the room temperature is below 16°C.

Refer to figure 3 on page [1]



Press ON/OFF button.

OPERATION lamp lights up or goes off and the system starts or stops OPERATION.

[EXPLANATION OF HEATING OPERATION]

DEFROST OPERATION

- As the frost on the coil of an outdoor unit increase, heating effect decreases and the system goes into DEFROST OPERATION.
- The indoor unit fan stops and the control panel display shows “”.
- After 6 to 8 minutes (maximum 10 minutes) of DEFROST OPERATION, the system returns to HEATING OPERATION.

Regarding outside air temperature and heating capacity

- The heating capacity of the air conditioner declines as the outside air temperature falls. In such a case, use the air conditioner in combination with other heating systems.
- A warm air circulating system is employed, and therefore it takes some time until the entire room is warmed up after the start of operation.
- An indoor fan runs to discharge a gentle wind automatically until the temperature inside the air conditioner reaches a certain level. At this time, the control panel displays “”. Leave it as it stands and wait for a while.
- When the warm air stays under the ceiling and your feet are cold, we recommend that you use a circulator (a fan to circulate the air inside the room). For details, consult your dealer.

ADJUSTMENT

For programming TEMPERATURE, FAN SPEED and AIR FLOW DIRECTION, follow the procedure shown below.



TEMPERATURE SETTING

Press TEMPERATURE SETTING button and program the setting temperature.

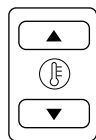

Each time this button is pressed, setting temperature rises 1°C.

Each time this button is pressed, setting temperature lowers 1°C.

- The setting is impossible for fan operation.

NOTE

- The setting temperature range of the control panel is 16°C to 32°C.



FAN SPEED CONTROL

Press FAN SPEED CONTROL button.

High or Low fan speed can be selected. The microchip may sometimes control the fan speed in order to protect the unit.



AIR FLOW DIRECTION ADJUST

There are two ways in adjusting the air flow direction.

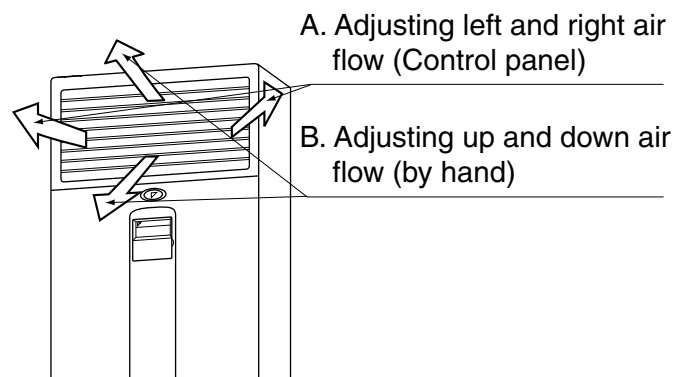

A. Adjusting left and right air flow

Press the AIR FLOW DIRECTION ADJUST button to select the air direction as shown below.

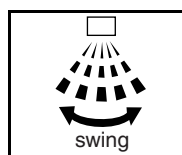

The AIR FLOW BLADE display swings as shown below and the air flow direction continuously varies. (Automatic swing setting)



Press AIR FLOW DIRECTION ADJUST button to select the air direction of your choice.

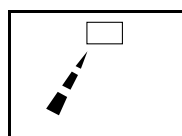

The AIR FLOW BLADE display stops swinging and the air flow direction is fixed. (Fixed air flow direction setting)

B. Adjusting up and down air flow

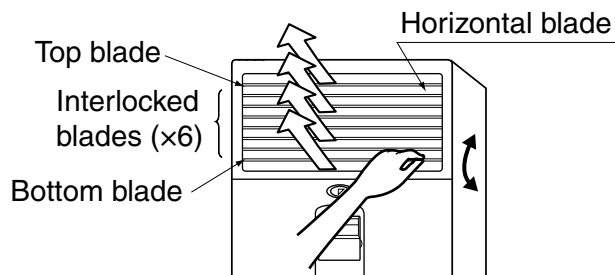

Adjust the horizontal blades with your hand. Do not forget to adjust the top and bottom independent blades.

Adjust the blades slightly upward when cooling, and slightly downward when heating.

NOTE

- Operating the unit with the upper flaps, interlocking flaps, and lower flaps overlapping may cause condensation to drip. Make sure the upper flaps, interlocking flaps, and lower flaps are all in the same direction.

PROGRAM TIMER OPERATION

Operate in the following order.

- The timer is operated in the following two ways.
Programming the stop time (⊕ · ○)
.... The system stops operating after the set time has elapsed.
Programming the start time (⊕ · |)
.... The system starts operating after the set time has elapsed.
- The timer can be programmed a maximum of 72 hours.
- The start and the stop time can be simultaneously programmed.

1 TIMER MODE START/STOP

Press the TIMER MODE START/STOP button several times and select the mode on the display.

The display flashes.

For setting the timer stop “⊕ · ○”

For setting the timer start “⊕ · |”

2 PROGRAMMING TIME

Press the PROGRAMMING TIME button and set the time for stopping or starting the system.

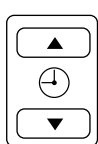

When this button is pressed, the time advances by 1 hour.

When this button is pressed, the time goes backward by 1 hour.

3



TIMER ON/OFF

Press the TIMER ON/OFF button.

The timer setting procedure ends.

The display “⊕ · ○ or ⊕ · |” changes from flashing light to a constant light.

Refer to figure 4 on page [1]

NOTE

- When setting the timer Off and On at the same time, repeat the above procedure from 1 to 3 once again.

When the timer is programmed to stop the system after 3 hours and start the system after 4 hours, the system will stop after 3 hours and then 1 hour later the system will start.

- After the timer is programmed, the display shows the remaining time.
- Press the TIMER ON/OFF button once again to cancel programming. The display vanishes.

7. OPTIMUM OPERATION

Observe the following precautions to ensure the system operates.

- Adjust the room temperature properly for a comfortable environment. Avoid excessive heating or cooling.
- Prevent direct sunlight from entering a room during cooling operation by using curtains or blinds.
- Ventilate the room regularly.
Using the unit for long periods of time requires attentive ventilation of the room.
- Keep doors and windows closed. If the doors and windows remain open, room air will flow out and cause to decrease the effect of cooling and heating.
- Do not place other heaters directly below the indoor unit.
They may deform due to the heat.
- Never place objects near the air inlet and the air outlet of the unit. It may cause deterioration in the effect or stop in the operation.
- Turn off the main power supply switch when it is not used for long periods of time. When the main power switch is turned on, some watts of electricity is being used even if the system is not operating. Turn off the main power supply switch for saving energy. When reoperating, turn on the main power supply switch 6hours before operation for smooth running (Refer to MAINTENANCE).
- When the display shows “” (TIME TO CLEAN AIR FILTER), ask a qualified service person to clean the filters (Refer to MAINTENANCE).

8. MAINTENANCE (FOR SERVICE PERSONNEL)

ONLY A QUALIFIED SERVICE PERSON IS ALLOWED TO PERFORM MAINTENANCE

IMPORTANT!

- **BEFORE OBTAINING ACCESS TO TERMINAL DEVICES, ALL POWER SUPPLY CIRCUITS MUST BE INTERRUPTED**
- To clean the air conditioner, be sure to stop operation, and turn the power switch off. Otherwise, an electric shock and injury may result.
- Do not wash the air conditioner with water. Doing so may result in an electric shock.
- Be careful with a scaffold or staging. Caution must be exercised because of work at a high place.

HOW TO CLEAN THE AIR FILTER

Clean the air filter when the display shows “” (TIME TO CLEAN AIR FILTER).

Increase the frequency of cleaning if the unit is installed in a room where the air is extremely contaminated.

If the dirt becomes impossible to clean, change the air filter. (Air filter for exchange is optional)

1. Open the suction grille.

Slide it forward slowly.

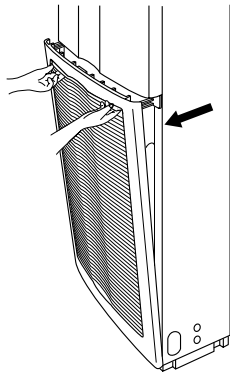

Please!

- Do not pull on the front panel. It opens only slightly.

2. Remove the air filters.

Pull the filter up and out carefully.

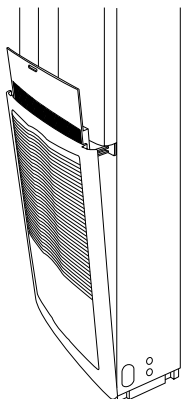

3. Clean the air filter.

Use vacuum cleaner **A)** or wash the air filter with water **B)**.

A) Using a vacuum cleaner



B) Washing with water

When the air filter is very dirty, use soft brush and neutral detergent.



Remove water and dry in the shade.

NOTE

- Do not wash the air conditioner with hot water of more than 50°C, as doing so may result in discoloration and/or deformation.
- Do not expose it to fire, as doing so may result in burning.

4. Reset the air filter in place.

After cleaning the filter, do not forget to put it back the way it was before.

5. Press the **FILTER RESET** button on the control panel.

The display “” (TIME TO CLEAN AIR FILTER) vanishes.

HOW TO CLEAN AIR OUTLET AND OUTSIDE PANELS

- Clean with soft cloth.
- When it is difficult to remove stains, use a damp cloth with some water-diluted neutral detergent. Wipe with a dry cloth afterwards.

NOTE

- Do not use gasoline, benzene, thinner, polishing powder, liquid insecticide. It may cause discoloring or warping.
- Do not use water or air of 50°C or higher for cleaning air filters and outside panels.

START UP AFTER A LONG STOP

Confirm the following

- Check that the air inlet and outlet are not blocked. Remove any obstacle.
- Check if the earth is connected. Might there be a broken wire somewhere? Contact your dealer if there are any problems.

Clean the air filter and outside panels

- After cleaning the air filter, make sure to attach it.

Turn on the main power supply switch.

- The display on the control panel will be shown when the power is turned on.
- To protect the unit, turn on the main power switch at least 6 hours before operation.

WHAT TO DO WHEN STOPPING THE SYSTEM FOR A LONG PERIOD

Turn on FAN OPERATION for a half day and dry the unit.

- Refer to "FAN OPERATION".

Cut off the power supply.

- When the main power switch is turned on, some watts of electricity is being used even if the system is not operating.
Turn off the main power supply switch for saving energy.
- The display on the control panel will vanish when the main power switch is turned off.

Clean the air filter and the exterior.

- Be sure to replace the air filter to its original place after cleaning. Refer to "MAINTENANCE".

9. NOT MALFUNCTION OF THE AIR CONDITIONER

The following symptoms do not indicate air conditioner malfunction.

I. THE SYSTEM DOES NOT OPERATE

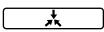
- **The system does not restart immediately after the ON/OFF button is pressed.**
If the OPERATION lamp lights, the system is in normal condition.
It does not restart immediately because a safety device operates to prevent overload of the system. After 3 minutes, the system will turn on again automatically.
- **The system does not restart immediately when TEMPERATURE SETTING button is returned to the former position after pushing the button.**
If the OPERATION lamp lights, the system is in normal condition.
It does not restart immediately because a safety device operates to prevent overload of the system. After 3 minutes, the system will turn on again automatically.
- **The system does not start when the display shows "  " (UNDER CENTRALIZED CONTROL) and it flashes for few seconds after pressing an operation button.**
This is because the system is under centralized control. Flashes on the display indicates that the system cannot be controlled by the control panel.
- **The system does not start immediately after the power supply is turned on.**
Wait one minute until the micro computer is prepared for operation.

• The outdoor unit stops.

The room temperature has reached the preset temperature. The indoor unit is in ventilation operation.

II. THE AIR CONDITIONER STOPS OPERATING FROM TIME TO TIME

- **The liquid crystal of the control panel shows "U4" or "U5" and the air conditioner stops operating, but it restarts operating in a few minutes.**

The air conditioner stops operating because the communication between the units is interrupted by electric noise generated from equipment other than the air conditioner. The air conditioner will restart operating when the electric noise is suppressed.

III. THE AIR VOLUME IS NOT IN CONFORMITY WITH THE SETTING

- **The air volume does not change with the air-flow adjustment button pressed.**

When the room temperature reaches the preset temperature, the outdoor unit will stop operating and the indoor unit will go into breezing operation.

IV. WHITE MIST COMES OUT OF A UNIT

- **When humidity is high during cooling operation (In oily or dusty places)**
If the inside of an indoor unit is extremely contaminated, the temperature distribution inside a room becomes uneven. It is necessary to clean the inside of the indoor unit. Ask your Daikin dealer for details on cleaning the unit. This operation requires a qualified service person.
- **When the system is changed over to HEATING OPERATION after DEFROST OPERATION.**
Moisture generated by DEFROST becomes steam and exists.

V. NOISE OF AIR CONDITIONERS

- **A ringing sound after the unit is started.**
This sound is generated by the temperature regulator working.
It will quiet down after about a minute.
- **A continuous flow "Shuh" sound is heard when the systems is in COOLING or DEFROST OPERATION.**
This is the sound of refrigerant gas flowing through both indoor and outdoor units.
- **A "Shuh" sound which is heard at the start or immediately after the stop of operation or which is heard at the start or immediately after the stop of DEFROST OPERATION.**
This is the noise of refrigerant caused by flow stop and flow change.

- **A continuous low “Shah” sound is heard when the system is in COOLING OPERATION or at a stop.**

The noise is heard when the drain pump is in operation.

- **A “Pishi-pishi” squeaking sound is heard when the system is in operation or after the stop of operation.**

Expansion and contraction of plastic parts caused by temperature change makes this noise.

VI. DUST FROM THE UNITS

- **Dust may blow out from the unit after starting operation from long resting time.**

Dust absorbed by the unit blows out.

VII. THE UNITS GIVE OFF ODORS

The unit absorbs the smell of rooms, furniture, cigarettes, etc., and then emits them.

VIII. THE LIQUID CRYSTAL OF THE CONTROL PANEL SHOW “88”

- **It happens immediately after the main power supply switch is turned on.**

This shows that the control panel is in normal condition.

This continues temporary.

IX. THE WIND DIRECTION DIFFERS FROM THE DISPLAY ON THE CONTROL PANEL

- **The AIR FLOW BLADE display on the control panel swings, but the actual airflow blade does not swing.**

While in heating operation: The air conditioner will be in wind direction control immediately after the air conditioner starts operating or when the room temperature is higher than the set temperature so that the people in the room will not be exposed to an unpleasant wind.

While in cooling or drying operation: The air conditioner will be in wind direction control while the room temperature is lower than the set temperature. See page 6.

- **The AIR FLOW BLADE display on the control panel differs in direction from the actual air flow blade.**

While in heating operation: The air conditioner will be in wind direction control immediately after the air conditioner starts operating or when the room temperature is higher than the set temperature so that the people in the room will not be exposed to an unpleasant wind.

X. THE ROOM TEMPERATURE DOES NOT DROP

- **The air conditioner is in program dry operation.**

The air conditioner in program dry operation does not drop the room temperature as much as possible. See page 5.

10. TROUBLE SHOOTING

- If one of the following malfunctions occurs, take the measures shown below and contact your Daikin dealer.**

The system must be repaired by a qualified service person.

⚠ WARNING

When the air conditioner is in abnormal conditions (smell of something burning, etc), unplug the power cord from the outlet, and contact your dealer

Continued operation under such circumstances may result in a failure, electric shock, and fire.

- If a safety device such as a fuse, a breaker or an earth leakage breaker frequently actuates;
Measure: Do not turn on the main power switch.
- If the ON/OFF switch does not properly work;
Measure: Turn off the main power switch.
- If water leaks from unit.
Measure: Stop the operation.
- If the display “” (INSPECTION), “UNIT No.”, and the OPERATION lamp flash and the “MALFUNCTION CODE” appears.

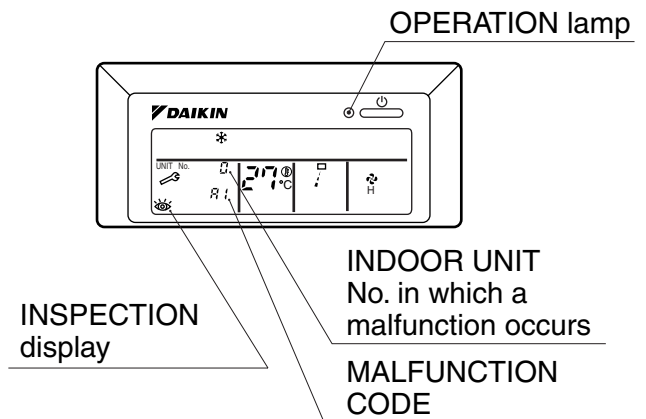

Measure: Notify your Daikin dealer and inform him/her of the display.

II. If the system does not properly operate except for the above mentioned case, and none of the above mentioned malfunctions is evident, investigate the system according to the following procedures.

1. If the system does not operate at all.

- Check if there is a power failure.
Wait until power is restored. If power failure occurs during operation, the system automatically restarts immediately after the power supply recovers.
- Check if no fuse has blown.
Turn off the power supply.
- Check if the breaker is blown.
Turn the power on with the breaker switch in the off position.
Do not turn the power on with the breaker switch in the trip position.
(Contact your dealer.)

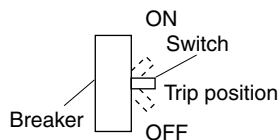

2. If the system stops operating after operating the system.

- Check if the air inlet or outlet of outdoor or indoor unit is blocked by obstacles.
Remove the obstacle and make it well-ventilated.
- Check if the air filter is clogged.
Ask a qualified service person to clean the air filters (Refer to MAINTENANCE).

3. The system operates but it does not sufficiently cool or heat.

- If the air inlet or outlet of the indoor or the outdoor unit is blocked with obstacles.
Remove the obstacle and make it well-ventilated.
- If the air filter is clogged.
Ask a qualified service person to clean the air filters (Refer to MAINTENANCE).
- If the set temperature is not proper (Refer to ADJUSTMENT).
- If the FAN SPEED button is set to LOW SPEED (Refer to ADJUSTMENT).
- If the air flow angle is not proper (Refer to ADJUSTING THE AIR FLOW DIRECTION).
- If the doors or the windows are open. Shut doors or windows to prevent wind from coming in.
- If direct sunlight enters the room (when cooling).
Use curtains or blinds.
- When there are too many inhabitants in the room (when cooling).
Cooling effect decreases if heat gain of the room is too large.

- If the heat source of the room is excessive (when cooling).
Cooling effect decreases if heat gain of the room is too large.

DAIKIN INDUSTRIES, LTD.

Head office:

Umeda Center Bldg., 2-4-12, Nakazaki-Nishi,
Kita-ku, Osaka, 530-8323 Japan

Tokyo office:

JR Shinagawa East Bldg., 2-18-1, Konan,
Minato-ku, Tokyo, 108-0075 Japan

DAIKIN EUROPE NV

Zandvoordestraat 300, B-8400 Oostende, Belgium